

The MAXI sprayer is a professional high-performance model with a very high output of 2.2 ml per stroke. The MAXI has an extremely robust construction, designed for constant use over a long period. It has a long contoured three-finger trigger for effort-free operation. The trigger surface is textured for an easy grip even with wet or gloved hands.

The nozzle is fully adjustable from a fine mist to a direct jet. A foamer nozzle is also available. The diptube filter is fitted as standard.

The Maxi is recommended for professional, industrial and janitorial use and for all applications where a large quantity of product sprayed is required.

General Information

- Ordering numbers : MAXI JTBS270BVER
- Spraying capacity : 2.2 ml
- Weight : 0.00 gr
- Color :
- Tube length : 270 mm

Neck : 28/400



Standard packaging :

- 400 pcs per box
- Dimensions : 57 x 39 x 55 cm
- Gross weight : 1.25 Kg

Photo



Exploded View

Pos	description	Material
1	Body	PP
2	Rivet	POM
3	Ring	PP
4	Ball	st. steel 302
5	Connection	PP
6	Tube	PE
7	Filter	PP
8	Trigger	PP
9	Washer holder	PP
10	Washer	NBR
11	Spring	st. steel 302
12	Nozzle	PP
13	Valve	POM
14	O-ring	NBR
15	Seal	PE/EPE

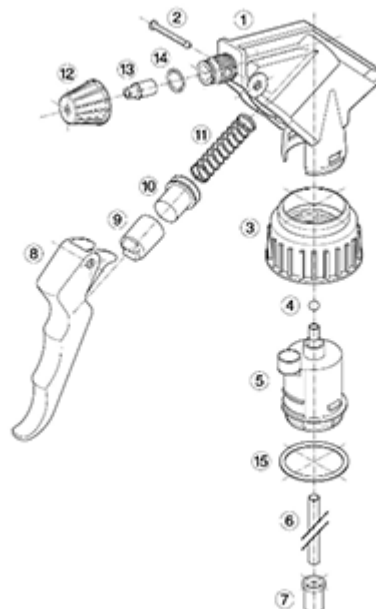

Media

